



**X-Wall FX-128; X-Wall FX-192; X-Wall FX-256  
X-Wall FX-128C; X-Wall FX-192C; X-Wall FX-256C  
USB2.0 to Serial ATA Real-time Cryptographic Processor  
Specification Rev. 1.4**

**Microsoft WHQL certifications**



**Revision History**

Rev No.	Description	Author	Rev. Date
1.0	Initial release.	C. Y. Chiu R. Wann B. Huang	06/03/2008
1.1	General editing.	C. Y. Chiu R. Wann B. Huang	07/04/2008
1.2	Updating Packaging Information	R. Wann	07/15/2008
1.2.1	Revise page 4 - Authentication	R. Wann	07/18/2008
1.3	Adding Power Trace Layout on page 16 Adding PCB Parameters for Differential Signals on page 17	C. Y. Chiu B. Huang	12/26/2008
1.4	Add electrical characteristics over power consumption on page 19; Update operating temperature on page 19; General editing	C. Y. Chiu R. Wann	04/08/2009
	Intentionally left blank		

**Asia**

**Enova Technology Corporation**  
1<sup>st</sup> Floor, #11, Research & Development 2<sup>nd</sup> Rd.  
Science-based Industrial Park, Hsin-Chu City  
Taiwan 30076, Republic of China  
Tel. +886 3 577 2767  
Fax +886 3 577 2770  
<http://www.enovatech.net>  
[info@enovatech.net](mailto:info@enovatech.net)

**North America**

**Enova Technology**  
8130 Remmet Avenue, Suite 201  
Canoga Park, California 91304, USA  
Tel. +1 510.825.7900

<http://www.enovatech.com>  
[info@enovatech.com](mailto:info@enovatech.com)

## Table of Content

Background .....	4
<i>Functional Blocks</i> .....	4
<i>Authentication</i> .....	5
<i>X-Wall FX 2-wire Serial Interface Basic</i> .....	6
<i>Solutions Using the X-Wall FX</i> .....	7
<i>One Time Setup Making Truly Portable</i> .....	8
<i>Support Over Than 2TB</i> .....	8
<i>Advanced and Basic Version</i> .....	9
<i>Administrator Password Controls Users Access</i> .....	9
<i>Reliable Disk Operation Using Enova Real-time Encryption Technology</i> .....	9
<i>Features</i> .....	10
<i>System Requirement</i> .....	10
X-Wall FX Pin Definitions .....	11
<i>Pin Assignment</i> .....	11
PCB Layout Guidelines .....	15
<i>Typical Application Schematics</i> .....	15
<i>Typical Bill of Materials (BOM)</i> .....	15
<i>Component Placement</i> .....	17
<i>PCB Trace Routing</i> .....	17
SATA Signal Layout .....	17
USB Signal Layout .....	17
Power Trace Layout .....	17
PCB Parameters of Differential Signals .....	18
Electrical Characteristics .....	19
<i>Absolute Maximum Ratings</i> .....	19
<i>DC Characteristics</i> .....	19
Package information .....	20
<i>Feathers</i> .....	20

## Background

Enova Technology proudly introduces *X-Wall FX*, the USB/SATA real-time cryptographic bridge processor that is capable of conducting real-time full disk encryption over the connected SATA disk drives<sup>1</sup>. The **patents protected<sup>2</sup> FX** is the 8<sup>th</sup> generation of the *X-Wall* real-time full disk encryption technology. It equips with tightly integrated USB 2.0 and SATA interface controller that allows the connection of SATA disk drives to a host USB 2.0 interface controller, making it a perfect fit for modern USB interfaced external storage enclosure as well as other USB and SATA related security storage solutions. Additionally, the *FX* offers NIST and CSE certified real-time hardware AES<sup>3</sup> security up to 256-bit encryption strength to safeguard the entire content of the SATA disk drive. The operations of encryption and decryption are totally transparent for reliable disk drive operations. Your privacy and confidentiality are always kept safely from prying eyes with the *FX* enabled.

Most importantly, the *X-Wall FX* is authenticated by a password entry from your personal computer keyboard as a pre-boot condition. At initialization, you get to select your pass phrase and the *FX* writes both **encrypted** pass phrase and AES secret key to the connected SATA disk drive. The loading of all authentication software is completely transparent to all users to ensure that there are no user interruptions. For user login, the password entry will be compared internally inside the *FX* to avoid attacks attempted over the host computer.

The *X-Wall FX* offers absolutely no performance degradation<sup>4</sup> during entire cryptographic operations. In lots of applications, the *X-Wall FX* enhances the speed and performance of your disk read/write. Thanks to its advanced real-time pipeline engine design, the *X-Wall FX* with its hardware AES engine enabled, surpasses all other generic peer controllers.

### **Functional Blocks**

As shown in Figure 1, the *X-Wall FX* offers a standard USB 2.0 device controller to the host computer and a standard SATA host controller to allow the controls over a SATA based disk drive including solid state disk (SSD). Without the enabling of the powerful real-time AES cryptographic capability, the *FX* simply serves as a standard USB 2.0 to SATA disk controller.

---

<sup>1</sup> SATA 2.0 drives can be operated on the *X-Wall FX* without performance degradation.

<sup>2</sup> **US patents 7,136,995; 7,386,734; and Application 11/282,175.**

<sup>3</sup> NIST and CSE certification is essential as the authenticity and quality of AES implementation are proven. Enova Technology's hardware AES ECB and CBC crypto engine certifications can be viewed at [www.enovatech.com](http://www.enovatech.com).

<sup>4</sup> The performance test report can be viewed at our website.

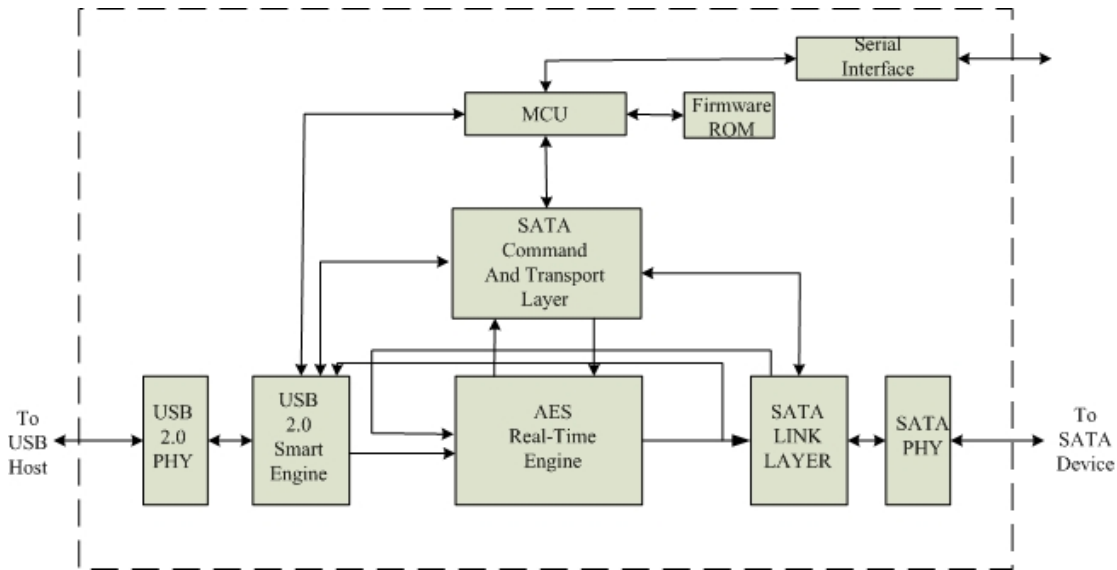

Figure 1 -- The Functional Block of X-Wall FX

Engineering design is simple and straight forward with the X-Wall FX as both standard USB 2.0 PHY and Smart Engine are built in. More, the SATA interface controller PHY, Link, and Transport layers are tightly integrated with all the USB functional blocks to form the complete circuit. Real-time hardware AES cryptographic engine is at the heart of the entire circuit, offering real-time no performance loss performance to both USB host and SATA device controller (the SATA disk drive). An embedded micro controller manages Power-On-Self-Test (POST) and several cryptographic operations/functions including Built-In-Self-Test (BIST), 2-wire serial communication protocol, and password authentication.

### **Authentication**

**Authentication** is provided through either Host Password or built-in 2-Wire Serial Protocol. **You can not use both as they are mutually exclusive.** Either the Host Password or the 2-Wire Serial Protocol authentication method enables the built-in real-time hardware AES capabilities. There are certain constraints in using those however.

For Host Password, the limitation lies over the Operating System the X-Wall FX would be able to support. Please reference to **System Requirement** at page 9 for details. Having said, without using the Host Password, the X-Wall FX simply acts as a standard USB/SATA bridge controller without providing the real-time hardware AES capabilities.

For Device Side Authentication using 2-wire Serial Protocol, extra micro controller is needed to communicate properly during user authentication. The design can be versatile including those popular Finger Print, Smart Card, Key Pad, Key Fob, or any combination. If none of the Host Password and

2-wire Serial Protocol is been used, the **X-Wall FX** simply acts as a standard USB/SATA bridge controller without providing the real-time hardware AES capabilities.

**Host Password** – Password based authentication software are supported to allow fast to market. Password management can be customized to meet with your specific design taste and requirement. The Advanced vs. Basic version **X-Wall FX** offers unique proposition in security and password management, which are done through software and continuous upgrade. **Enova Technology also offers advanced SDK<sup>5</sup> to help facilitate various designs, including remote access and management.**

**2-Wire Serial Protocol** – Just like all prior generation **X-Wall** family chips, the **X-Wall FX** equips with 2-wire serial protocol for key loading that enables the real-time hardware AES cryptographic engine. The 2-wire serial protocol and password are mutually exclusive, meaning authentication can only choose either one, not both. Below diagram shows the 2-wire serial protocol timing that designers may follow through.

**X-Wall FX 2-wire Serial Interface Basic**

The bus interface has two bus wires. The first one, namely SDAH, is used for transmitting and receiving serial bit data. The second one, namely SCLH, is used for transmitting (master mode) and receiving (slave mode) clock pulses. By combining those two signals the START, repeated START, and STOP conditions are created, which are then used for constructing entire bus protocol. Listed below are signal-timing specification of SDAH and SCLH.

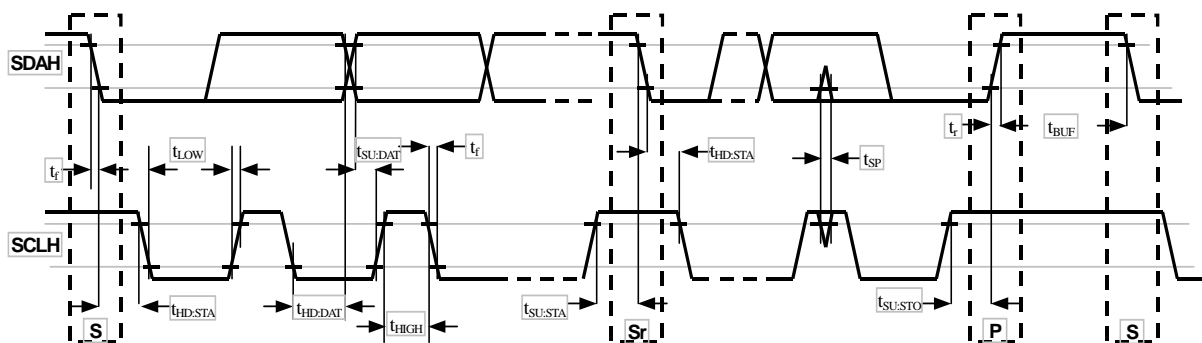

PARAMETER	SYMBOL	MIN.	MAX.	UNIT
SCL clock frequency	$f_{SCL}$	0	400	kHz
Hold time (repeated) START condition (S). After this	$t_{HD:STA}$	0.6	-	$\mu s$

<sup>5</sup> The SDK is available for licensing. This powerful SDK allows the designers to control specific registers and hard disk sectors. Consult with Enova Engineering at [info@enovatech.com](mailto:info@enovatech.com) for licensing details.

period the first clock pulse is generated.				
LOW period of the SCL clock	$t_{LOW}$	1.3	-	$\mu s$
HIGH period of the SCL clock	$t_{HIGH}$	0.6	-	$\mu s$
Set-up time for a repeated START condition ( <b>Sr</b> )	$t_{SU:STA}$	0.6	-	$\mu s$
Data hold time	$t_{HD:DAT}$	0	0.9	$\mu s$
Data set-up time	$t_{SU:DAT}$	100	-	ns
Rise time for both SDA and SCL signals	$t_r$	$20+0.1C_b$	300	ns
Fall time for both SDA and SCL signals	$t_f$	$20+0.1C_b$	300	ns
Setup time for STOP condition ( <b>P</b> ).	$t_{SU:STO}$	0.6	-	$\mu s$
Bus free time between a STOP and a START condition.	$t_{BUF}$	1.3	-	$\mu s$
Pulse width of spikes, which must be suppressed by the input filter.	$t_{SP}$	0	50	ns
$C_b$ : total capacitance of one bus line if pf.				

**Solutions Using the X-Wall FX**

**USB Portable Drive** – The X-Wall FX real-time cryptographic processor along with its built-in password authentication software serve as a complete single chip solution for all USB 2.0 based external storage including SATA based disk drive and solid state disk. As shown in **Figure 2, A real-time hardware AES secured USB portable disk**, the system configuration is the same as a regular USB 2.0 external storage enclosure except that FX offers unprecedented NIST and CSE certified hardware real-time AES encryption capability for both ECB (Electronic Code Book) and CBC (Cipher Block Chaining) mode of operations.

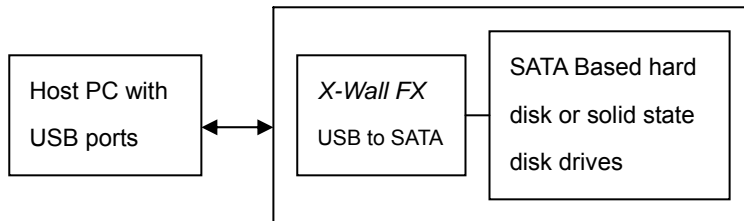

**Figure 2 -- A real-time hardware AES secured USB portable disk**

**Secure Motherboard** – The FX can be mounted over a standard motherboard auxiliary USB port, making the USB port secured for an external SATA disk drive connection. The external SATA disk drive can be as easy as a SATA disk with fixture (without any type of bridge controller) only. Please reference below **Figure 3, A real-time hardware AES secured SATA and Solid State Disk**, of which the connected SATA disk or Solid State Drive is secure without any extra bridge controller as the main functions are been performed over the X-Wall FX, which is directly mounted over the mainboard.

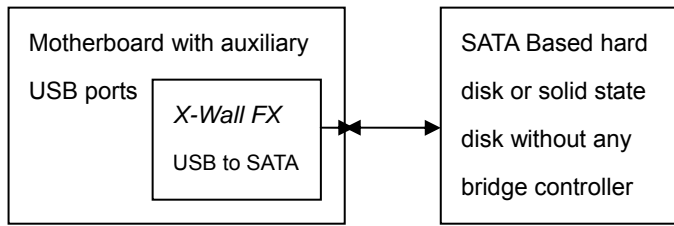

**Figure 3 -- A real-time hardware AES secured SATA and Solid State Disk**

**Secure SATA Disk Array Over Than 2TB** – The X-Wall FX real-time cryptographic processor along with its built-in password authentication software serve as a complete single chip solution for all USB 2.0 based external SATA based disk array. The entire SATA disk array is secured using single X-Wall FX controller, as long as the disk array has equipped with a standard SATA connection to the host. As shown in **Figure 4, A real-time hardware AES secured USB disk array**, the system configuration is the same as a regular USB 2.0 external storage enclosure except that FX offers unprecedented NIST and CSE certified hardware real-time AES encryption capability for both ECB (Electronic Code Book) and CBC (Cipher Block Chaining) mode of operations.

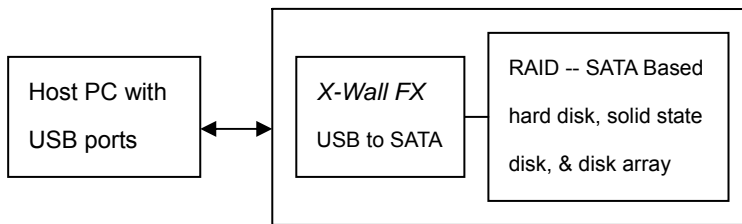

**Figure 4 -- A real-time hardware AES secured SATA Disk Array Over Than 2TB**

**One Time Setup Making Truly Portable**

The initialization procedure takes only one time and does not require you to conduct another setup procedure when you move your X-Wall FX secured USB portable drive to another host computer, making the portable drive truly portable and secure wherever you travel. To access the secure portable USB disk while you travel, simply double-click the setup files found over the secure portable disk drive then enter your password.

**Support Over Than 2TB**

The X-Wall FX supports over than 2 Tera Bytes of the USB external storage, which means you get to connect a SATA based RAID disk array over than 2TB but are still able to enjoy the hardware real-time AES security over the entire disk array using only one single X-Wall FX chipset. Please be advised, however, that the SATA based RAID disk array will need to be equipped with a SATA input

interface for proper connection to the SATA interface controller of the *FX*. The password based authentication software will still function correctly under this type of configuration. The *FX* solution offers yet another unprecedented disk volume support.

### ***Professional and Premium Version***

There will be a family of six (6) *X-Wall FX* chips with different bundled authentication software. The cryptographic strength of all six is different and is therefore listed below:

<b>Ordering Code (SKU)</b>	<b>AES Mode of Operation</b>	<b>Real-time Cryptographic Strength</b>	<b>Authentication Software Bundled</b>
X-Wall FX-128	Electronic Code Book	128-bit	Premium
X-Wall FX-192	Electronic Code Book	192-bit	Professional
X-Wall FX-256	Electronic Code Book	256-bit	Professional
X-Wall FX-128C	Cipher Block Chaining	128-bit	Professional
X-Wall FX-192C	Cipher Block Chaining	192-bit	Professional
X-Wall FX-256C	Cipher Block Chaining	256-bit	Professional

### ***Administrator Password Controls Users Access***

The Advanced version of the *X-Wall FX* equips with both Administrator and User Password. The Administrator gets to manage the user's password in terms of issuance, rights revocation, alternation, and recovery. There is an interlocking mechanism on the number of either the user or administrator's failed attempts. Once the user is locked after multiple failed attempts, only the Administrator can unlock the *X-Wall* secure SATA disk drives. The Basic version offers only User Password and similar interlocking mechanism. Attempts to probe into the passwords are futile as both are encrypted using the hardware AES cryptographic engine that *X-Wall FX* equips.

### ***Reliable Disk Operation Using Enova Real-time Encryption Technology***

Hardware encryption is always better than software in terms of security and reliability. For one thing, hardware does not crash your data like software often does. The crash over using a software encryption product usually causes irreparable harm. By using an Enova *X-Wall FX* solution, you get to perform all regular software backup tasks without complications. Additionally, the software encryption product needs a clear text key for cryptographic operations and such key resides in the system memory. A memory dump can easily recover such key value thus defeat the whole purpose of being

secure. The *FX* uses the same clear text key but only within its internal key registers which are not readable through any interfaces. When the power is gone, the entire content of the key registers are gone, thus can successfully defeat the exploitation of the keys through any type of memory dump techniques. More, the *FX* performs all cryptographic functions within the chip level to ensure the highest attainable security level.

### **Features**

1. Complies with SATA 2.6 Specification
2. Complies with USB2.0 Specification
3. Tightly integrated USB2.0 and SATA interface single chip controller
4. Supports hardware real-time AES cryptographic capability to entire SATA disk drive including SSD (Solid State Disk) up to 256-bit in both ECB and CBC mode
5. Supports standard USB/SATA bridge function without AES cryptographic function
6. Supports LBA 48-bit addressing
7. Supports over than 2TB per *X-Wall FX*
8. Low profile 64-pin QFP package

### **System Requirement**

1. USB2.0 High Speed at 480Mbit/sec and Backward Compatible;
2. All SATA Disk Drives including SATA Compliant SSD;
3. Windows Vista 32/64-bit, XP 32-64-bit, Windows 2000 32-bit With Real-time Cryptographic AES Strength Through Either Host Password or 2-Wire Serial Protocol authentication (Device Password);
4. **Host Password and 2-Wire Serial Protocol Are Mutually Exclusive;**
5. **All Operating Systems** For A Standard USB/SATA Bridge Controller (Without Real-time Cryptographic AES Capabilities);
6. **All Operating Systems Using Only 2-Wire Serial Protocol For Real-time Cryptographic AES Cryptographic Capabilities;**

## X-Wall FX Pin Definitions

### Pin Assignment

All X-Wall FX family ASIC shares the same pin assignment and pin definition. Upgrading from a lower strength, for instance, from an X-Wall FX-128 to an X-Wall FX-256 is as easy as replacing the chip and the actual Secret Key.

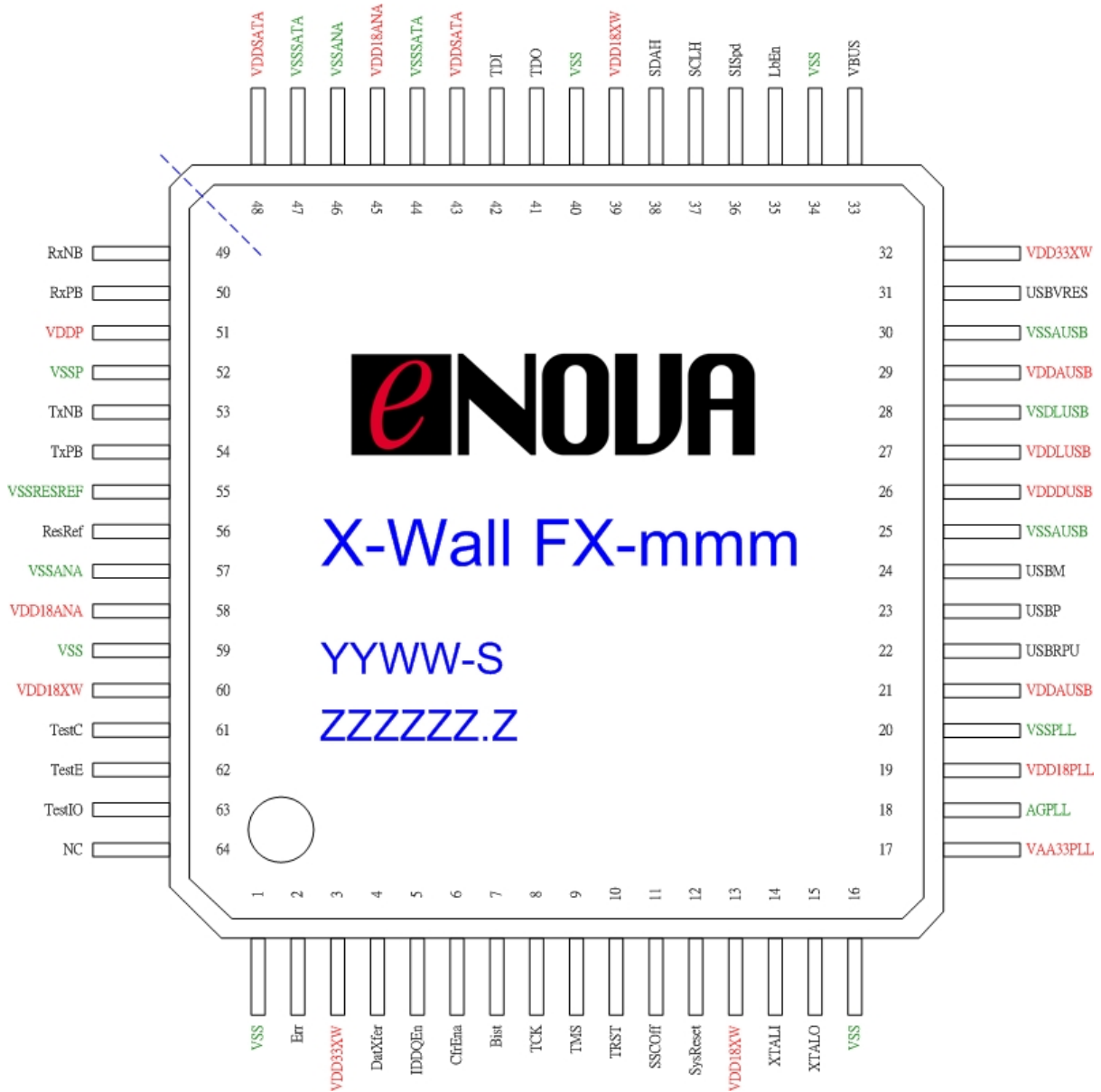

SATA PHY INTERFACE				
NAME	PIN*	DIR	TYPE	DESCRIPTION
pinRxPB	50	I		Receiving differential input signals for SATA channel.
pinRxNB	49			
pinTxPB	54	O		Differential serial output transmit signal for SATA channel.
pinTxNB	53			
pinResRef	56	I/O		Reference register, terminated to pin VSSREFREF through 2.7K±1% ohms.
Total	5			
USB PHY INTERFACE				
NAME	PIN	DIR	TYPE	DESCRIPTION
pinUSBP	23	I/O		USB data pin data+
pinUSBM	24	I/O		USB data pin data-
pinUSBRPU	22	I/O		Connected to an external 1.5K Ohm pull-up resister.
pinUSBVRES	31	I/O		Connected to an external 6.195K Ohm resistor for band-gap reference circuit.
pinVBUS	33	I		Connect to VCC at USB connector to detect if USB Bus is connected.
Total	5			
CLOCK AND PLL CONTROL PINS				
NAME	PIN	DIR	TYPE	DESCRIPTION
pinXTALI	14	I		Crystal/reference clock input.
pinXTALO	15	O		Crystal/reference clock output
Total	2			
FEATURE SETTING PINS				
NAME	PIN	DIR	TYPE	DESCRIPTION
pinCfrEna	6	I		Cryptographic engine enabled.
pinSSCOff	11	I		Turn off (HIGH) SSC mode for transmitting.
Total	2			
CONTROL AND INDICATE SIGNALS				
NAME	PIN	DIR	TYPE	DESCRIPTION
pinSysReset	12	I		Hardware master reset.
pinErr	2	O		If BIST is set to logic one, a HIGH at this pin indicates that the build-in self-test in PHY has failed. If cryptographic mode is selected, an active HIGH at this pin indicates that errors found in reading Key data, Key token not attached, or power-up self-test (POST) for Cipher Engine has failed.
pinDatXfer	4	O		Active LOW at this pin indicates that X-Wall FX has detected data transfer activities on its channels.
Total	3			
2-WIRE SERIAL INTERFACE				
NAME	PIN	DIR	TYPE	DESCRIPTION
pinSDAH	38	I/O	8mA	2-Wire Serial Data.
pinSCLH	37	I/O	8mA	2-Wire Serial Clock.
pinSISpd	36	I		Select 2-wire serial interface speed. Standard speed = 1, fast speed = 0.
Total	3			
JTAG TEST PINS				
NAME	PIN	DIR	TYPE	DESCRIPTION

pinTCK	8	I		Test clock.																																				
pinTDI	42	I		Test data input.																																				
pinTDO	41	O		Test data output.																																				
pinTMS	9	I		Test mode select.																																				
pinTRST	10	I		Test reset.																																				
Total	5																																							
DEBUG INTERFACE																																								
NAME	PIN	DIR	TYPE	DESCRIPTION																																				
pinIDDQEn	5	I		When asserted high, puts sataPhy into iDDQ test mode, whereby all PLLs are disabled. This input is used for leakage current testing. The power on reset signal (pOR) must be asserted high prior to taking an iDDQ measurement. When negated low, this signal allows the PLLs to resume normal operation.																																				
pinBist	7	I		Turn on (HIGH) build-in-self-test (BIST) mode of PHY.																																				
pinLbEn	35	I		PHY loop back mode enable under functional test (testIO = 0, testC = 1, and testE = 1).																																				
pinTestC pinTestE pinTestIO	61 62 63	I		Select test modes for scan tests and functional tests. Under scan modes, PLL is powered down and its REF clock is multiplexed to the PLLOUT clock to facilitate scan testing.  <table border="0"> <tr> <td>testIO</td> <td>testC</td> <td>testE</td> <td>MODE</td> </tr> <tr> <td>0</td> <td>0</td> <td>0</td> <td>Normal operation</td> </tr> <tr> <td>0</td> <td>0</td> <td>1</td> <td>Scan test for Digital core</td> </tr> <tr> <td>0</td> <td>1</td> <td>0</td> <td>Scan test for Analog core</td> </tr> <tr> <td>0</td> <td>1</td> <td>1</td> <td>Functional tests</td> </tr> <tr> <td>1</td> <td>0</td> <td>0</td> <td>SATA PHY transmit LFTP (D30.3)</td> </tr> <tr> <td>1</td> <td>0</td> <td>1</td> <td>SATA PHY transmit MFTP (D24.3)</td> </tr> <tr> <td>1</td> <td>1</td> <td>0</td> <td>SATA PHY transmit HFTP (D10.2)</td> </tr> <tr> <td>1</td> <td>1</td> <td>1</td> <td>SATA PHY transmit LBP</td> </tr> </table>	testIO	testC	testE	MODE	0	0	0	Normal operation	0	0	1	Scan test for Digital core	0	1	0	Scan test for Analog core	0	1	1	Functional tests	1	0	0	SATA PHY transmit LFTP (D30.3)	1	0	1	SATA PHY transmit MFTP (D24.3)	1	1	0	SATA PHY transmit HFTP (D10.2)	1	1	1	SATA PHY transmit LBP
testIO	testC	testE	MODE																																					
0	0	0	Normal operation																																					
0	0	1	Scan test for Digital core																																					
0	1	0	Scan test for Analog core																																					
0	1	1	Functional tests																																					
1	0	0	SATA PHY transmit LFTP (D30.3)																																					
1	0	1	SATA PHY transmit MFTP (D24.3)																																					
1	1	0	SATA PHY transmit HFTP (D10.2)																																					
1	1	1	SATA PHY transmit LBP																																					
Total	6																																							
POWER GROUND																																								
NAME	PIN	DIR	TYPE	DESCRIPTION																																				
pinVDD18ANA	45 58			Analog 1.8V power for SATA PHY core.																																				
pinVSSANA	46 57			Analog ground of VDD18ANA. At least 2 VDD18ANA/VSSANA pairs should be used.																																				
pinVDDSATA	43 48			Digital 1.8V supply not to be shared with global digital supply.																																				
pinVSSSATA	44 47			Digital ground of VDDSATA. Not to be shared with global digital ground. At least 3 VDDSATA/VSSSATA pairs should be used.																																				
pinVSSRESREF	55			Analog ground return for the external resistor reference. Should be as close to pinResRef as possible.																																				
pinVDDP	51			At least one for each Tx/Rx pair. And at least one un-bonded for each Tx/Rx pair for extra ESD protection.																																				
pinVSSP	52			At least one for each Tx/Rx pair. And at least one un-bonded for each Tx/Rx pair for extra ESD protection.																																				
PRCUT1P				Used for DC isolation between supply domains (with different DC voltage) in IO ring																																				
pinVDD33XW	3 32			Digital 3.3V supply of X-Wall FX I/O.																																				
pinVDD18XW	13 39 60			Digital 1.8V supply of X-Wall FX core.																																				

pinVSSXW	1 16 34 40 59			Digital ground of X-Wall FX I/O and core.
pinVDD18PLL	19			Digital 1.8V core power supply for PLL.
pinVSSPLL	20			Digital ground of pinVDD18PLL.
pinVAA33PLL	17			Analog 3.3V supply for PLL.
pinAGPLL	18		PVSS1A	Analog ground of pinVAA33PLL.
pinVDDAUSB	21 29			3.3V analog power for USB macro.
pinVSSAUSB	25 30			Analog ground for USB macro.
pinVDDDUSB	26			3.3V digital power for USB macro.
pinVDDLUSB	27			1.8V digital power for USB macro.
pinVSDLUSB	28			Digital ground for USB macro.
Total	32			

## PCB Layout Guidelines

### Typical Application Schematics

In a typical USB/SATA external storage enclosure application, the X-Wall FX is the single controller on board that controls both USB host and SATA device (the SATA disk drive). The typical password authentication does not require connection over the 2-wire serial bus but LED indicators may be included. For the detailed circuit layout files and Bill of Materials, please visit our website to download the latest revision. For special feature implementation such as customized SDK and some software source codes and related features, make a request with Enova Engineering at info@enovatech.com.

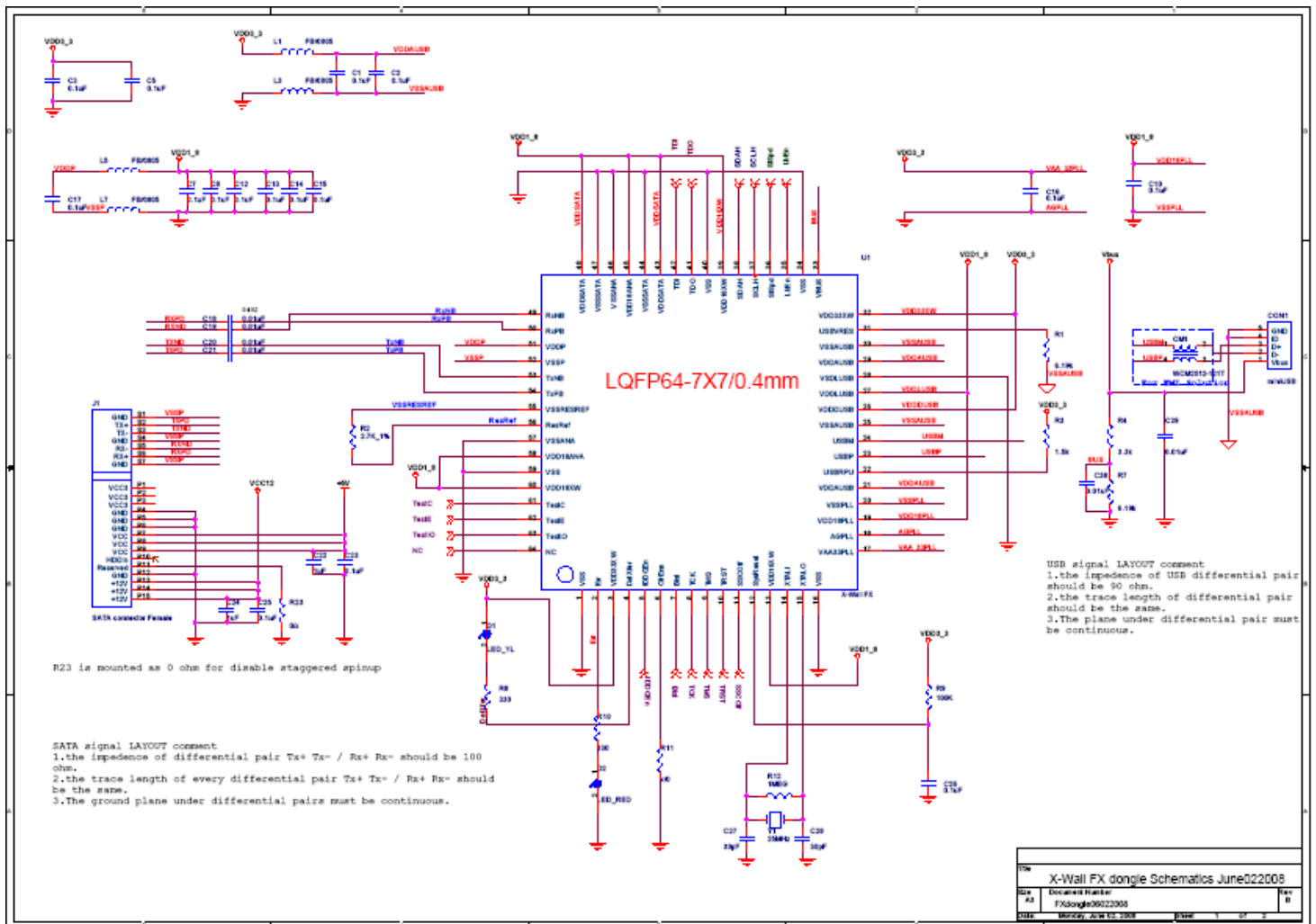

### Typical Bill of Materials (BOM)

Item	Quantity	Reference	Part
1	1	CM1	WCM2012-121T or 0 ohm*

2	2	CON2,CON1	Mini-USB
3	19	C1,C2,C3,C5,C7,C8,C10, C12,C13,C14,C15,C16, C17,C23,C25,C26,C33,C36,C37	0.1uF
4	6	C18,C19,C20,C21,C38,C39	0.01uF/0402
5	2	C22,C24	1uF
6	2	C27,C28	30pF
7	5	C29,C31,C32,C34,C35	10uF/16V TANT B
8	1	D1	LED_YL/0603
9	1	D2	LED_RED/0603
10	1	J1	SATA connector Female DIP RA
11	1	J2	DC JACK-3/1.3mm
12	4	L1,L3,L5,L7	FB/0805
13	2	R7,R1	6.19k
14	1	R2	2.7K_1%
15	3	R3,R16,R17	1.5K
16	1	R4	3.3k
17	2	R10,R8	330
18	1	R9	100K
19	5	R11,R13,R14,R18,R20,R22	x/0
20	1	R12	1MEG
21	1	R15	10K
22	2	R21,R19	33
23	1	R23	0
24	1	U1	X-Wall FX
25	1	U2	AIC1117-33/SOT223
26	1	U3	AIC1117-18/SOT223
27	1	U4	AT24C02B 8P/SOIC
28	1	Y1	25MHz DIP

\* Common choke is reserved for EMI solution .Two 0 ohm resistors can be mounted between pin1&pin2 and pin3&pin4 for USB signal connection if there isn't any EMI concern.

### **Component Placement**

- ◆ For each power pin, add one bypass capacitor, which should be placed closely to the power pin.
- ◆ The DC blocking capacitors on SATA signal traces (C18, C19, C20, and C21) should be placed closely to *X-Wall FX*.
- ◆ R1, R2, and R3 should be placed closely to *X-Wall FX*.
- ◆ The Crystal circuits should be placed closely to *X-Wall FX*.

### **PCB Trace Routing**

The *X-Wall FX* SATA signals routing can become really tricky thus deserves careful attention. The following bullets serve as a general guideline when the signal routing is attempted. Noted, however, this guideline does not cover the entire horizon of a complete design other than dealing with *X-Wall MX* specifically.

#### **SATA Signal Layout**

- ◆ To route the ResRef and VSSRESREF signals, **DO NOT** connect these signals to the ground and no other signals traces are routed near by these traces. Use 20mil trace width to route these traces and keep them as short as possible.
- ◆ The SATA TX signal pairs and SATA RX signal pairs **MUST HAVE** matching trace length. The difference of two line traces in either TX signal pairs or RX signal pairs should be restricted to below 150 mils.
- ◆ No other signals should be routed near by these SATA traces on **ANY** layers. There should be no more than one via on these traces; and there should be no stub on these traces. Recommend to use DIP type SATA connector to avoid using more than one via. Keep these traces as short as possible. A solid ground plane should be placed directly underneath these traces to have better signal quality.
- ◆ The SATA TX signal pairs and SATA RX signal pairs **MUST HAVE** 100Ω differential impedance. To achieve aforementioned impedance value, Please refer to the paragraph of "PCB Parameters of Differential Signals."
- ◆ Do not route SATA traces underneath the crystal circuits or any other chips that employ high clocking.

#### **USB Signal Layout**

All SATA layout guidelines mentioned above must be followed precisely to guarantee the signal quality. When the USB differential signals are routed, please further include the followings:

- ◆ The impedance of the USB differential pair should be 90 ohms. Please refer to the paragraph "PCB Parameters of Differential Signals" to achieve aforementioned impedance value. The trace length of the USB differential pair should be the same. You may want to consult with PCB layout engineer to obtain the exact parameters.
- ◆ The plane under the USB differential pair must be continuous. VSSAUSB is the best ground plane which should be placed under USB signals.

#### **Power Trace Layout**

- ◆ PCB with dedicated power plane is recommended. If the PCB does not have a dedicated power plane (for example, a two layers PCB), then the power traces that connect the

power pin of USB connector to power regulator or directly to HDD, should be made as wide as possible. We suggest that the power trace width must be no less than 40mil.

- ◆ Follow the same rules to route the power traces output from power regulators.
- ◆ Place large capacitance capacitors at power pin of USB connector and at power input pin of power regulators. Electrolytic type capacitors are recommended.
- ◆ A USB mass storage device may consume more current than a single USB port can provide. Y-cable is recommended for this case. Make sure the USB cable is of good quality and could sustain the required amount current.

### PCB Parameters of Differential Signals

(Assume 1oz cooper density)

Type	Material (dielectric Constant)	PCB thickness	Dielectric thickness	Trace width	Trace spacing
2-layer <sup>6*</sup>	FR4 (4.2)	1.6 mm	57 mil	SATA : 7mil USB : 12mil	SATA : 5mil USB : 5mil
4-layer	FR4 (4.2)	1.6 mm	4.3 mil	SATA : 5mil USB : 6mil	SATA : 10mil USB : 8mil

<sup>6</sup> The layout engineer MUST follow this note precisely for a 2-layer PCB architecture is not a standard micro strip transmission line structure. There is a definite requirement to the spacing between the differential trace and the nearby cooper plane of the same layer. For PCB parameters specified above, this defined spacing is 8mil for SATA and is 9mil for USB.

## Electrical Characteristics

This section contains electrical specifications for the X-Wall FX. Please note, however, stressing conditions beyond the “Absolute Maximum Ratings” may cause permanent damage to the X-Wall FX device. Operating beyond the “operating conditions” is not recommended and extended exposure beyond “operating conditions” may adversely affect life and reliability of the X-Wall FX device.

### Absolute Maximum Ratings

Symbol	Parameter	Value		Unit
		Min	Max	
Ts	Storage Temperature	-55	+125	°C
Ta	Operating Temperature	-45	90	°C
VDD33	3.3V Digital Supply Voltage	-0.5	3.6	V
AVDD33	3.3V Analog Supply Voltage	-0.5	3.6	V
VDD18	1.8V Digital Supply Voltage	-0.5	1.93	V
AVDD18	1.8V Analog Supply Voltage	-0.5	1.93	V
VIN_IO33	Input Signal Voltage (Apply to 3.3V I/O pins)	-0.5	5	V
VO_IO33	Output Signal Voltage (Apply to 3.3V I/O pins)	-0.5	VDD33	V

### DC Characteristics

Operating Conditions: VDD33=AVDD33=3.3V ( $\pm 9.09\%$ ),  
VDD18=AVDD18=1.8V ( $\pm 7.22\%$ ), GND=0V

Symbol	Parameter	Value		Unit
		Min	Max	
VDD33	3.3V Digital Supply Voltage	3.0	3.6	V
AVDD33	3.3V Analog Supply Voltage	3.0	3.6	V
VDD18	1.8V Digital Supply Voltage	1.67	1.93	V
AVDD18	1.8V Analog Supply Voltage	1.67	1.93	V
IVDD33	3.3V Supply current (IVDD33 + IAVDD33)	9	63	mA
IVDD18	1.8V Supply current (IVDD18 + IAVDD18)	53	212	mA

### Package information

64-pin LQFP (Low-profile Quad Flat Package) provides low profile with 1.4mm body thickness, suitable for space concerned applications. Package size 7x7mm and lead-counts 64 are offered for portable, lightweight and low profile applications. **All Enova X-Wall FX chips comply with RoHS and Leaf-free specification.**

#### Features

- ◆ 7mm x 7mm body size with 64 lead counts
- ◆ Copper lead frame
- ◆ Refer to JEDEC MA026(ISSUE D)/BBD

#### Outline and Dimension

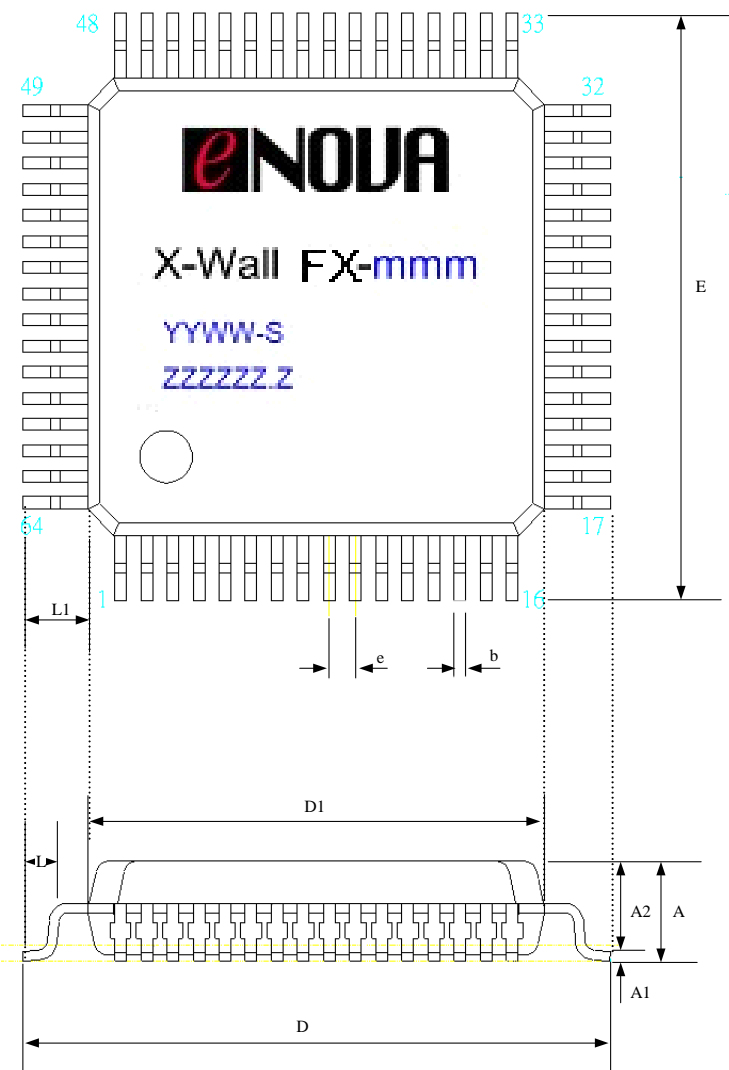

Symbol	Dimension [mm]		
	MIN	NOM	MAX
e	0.4 BSC		
b	0.13	0.18	0.23
D1	6.90	7.00	7.10
D, E	8.90	9.00	9.10
A			1.60
A1	0.05		0.15
A2	1.35	1.40	1.45
L1	1.00(REF)		
L	0.45	0.60	0.75

#### X-Wall FX top marking

mmm represents:

- 128, AES ECB 128 bits
- 192, AES ECB 192 bits
- 256, AES ECB 256 bits
- 128C, AES CBC 128 bits
- 192C, AES CBC 192 bits
- 256C, AES CBC 256 bits

yyww-s represents

Date Code

zzzzzz.z represents

Wafer lot number